

JUPITER 550-850 MED FAST GLAS 2 SIDER

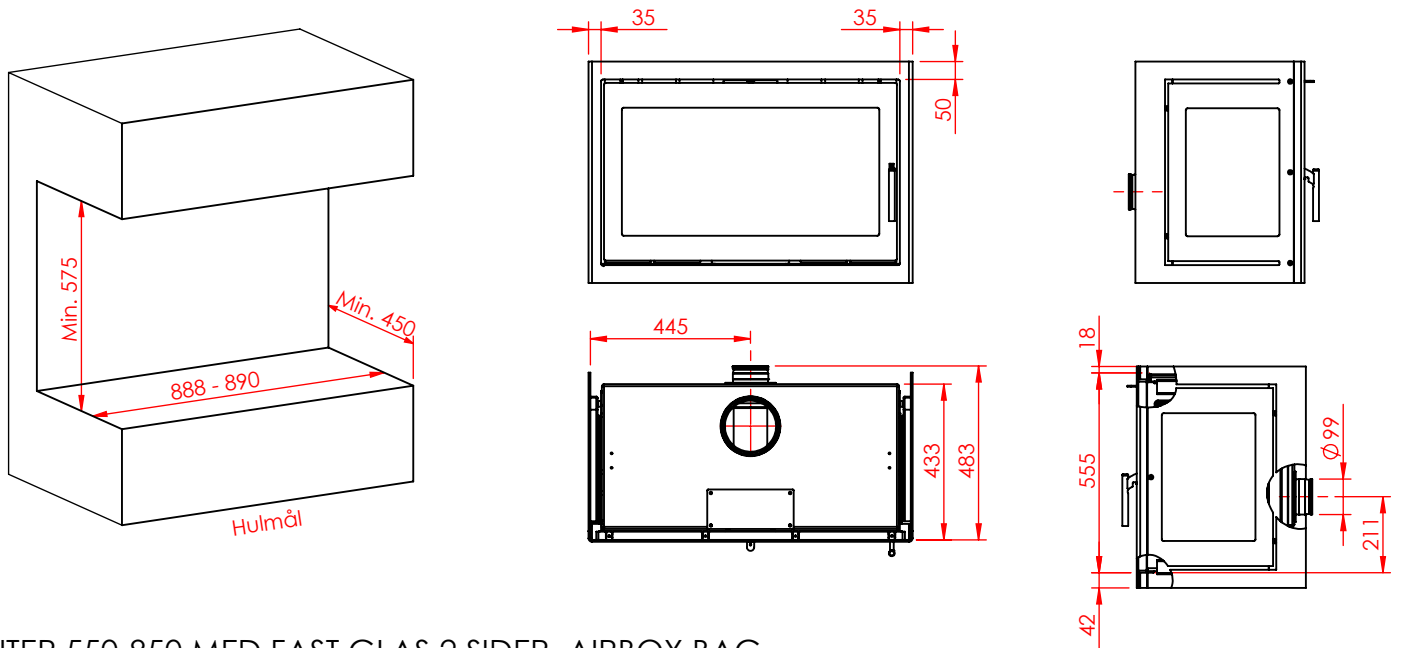

JUPITER 550-850 MED FAST GLAS 2 SIDER, AIRBOX BAG

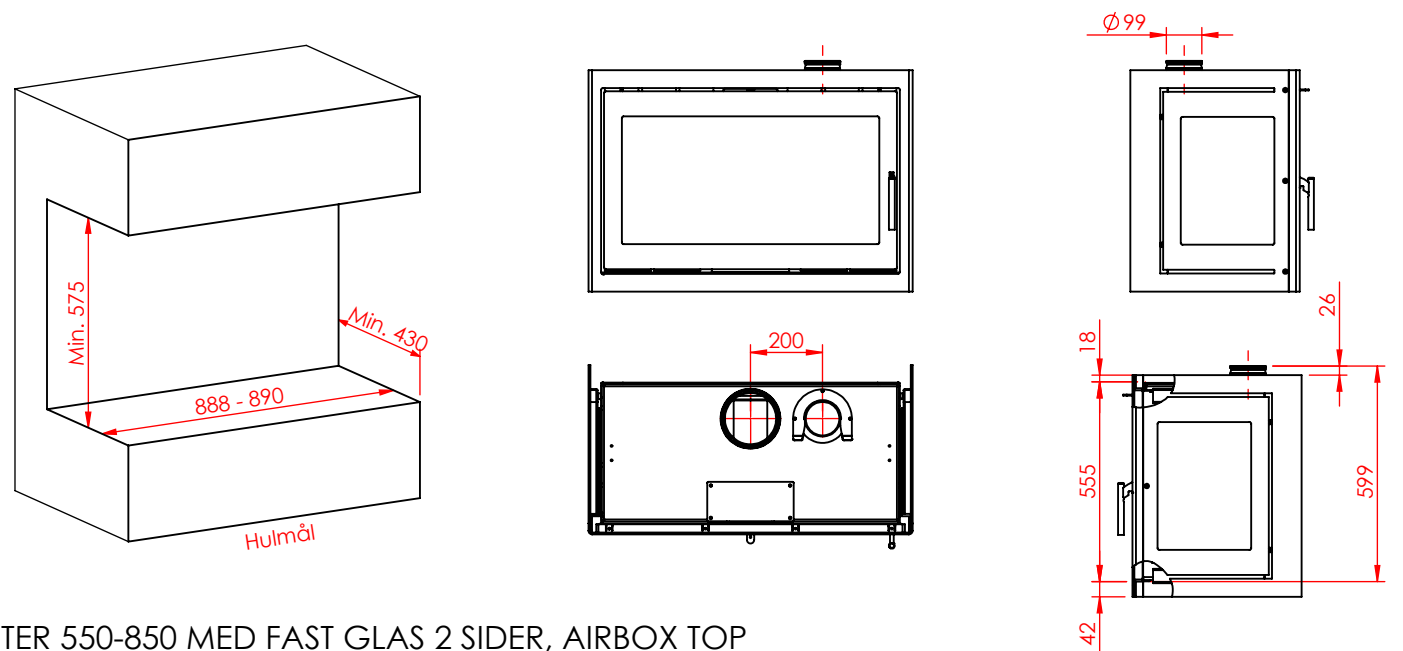

JUPITER 550-850 MED FAST GLAS 2 SIDER, AIRBOX TOP

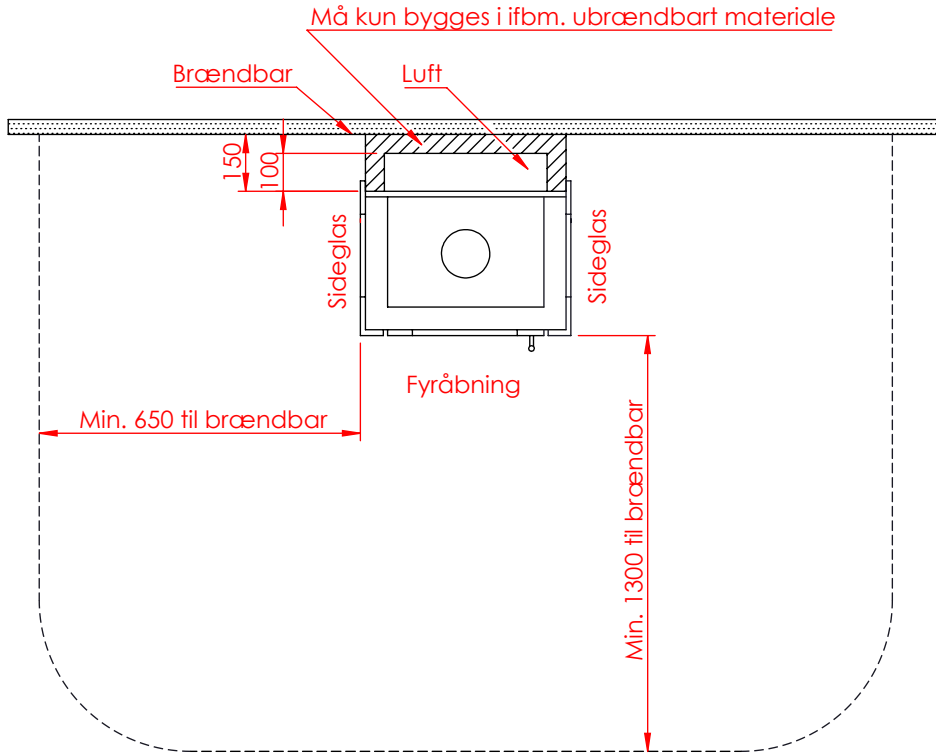

AFSTAND TIL BRÆNDBART

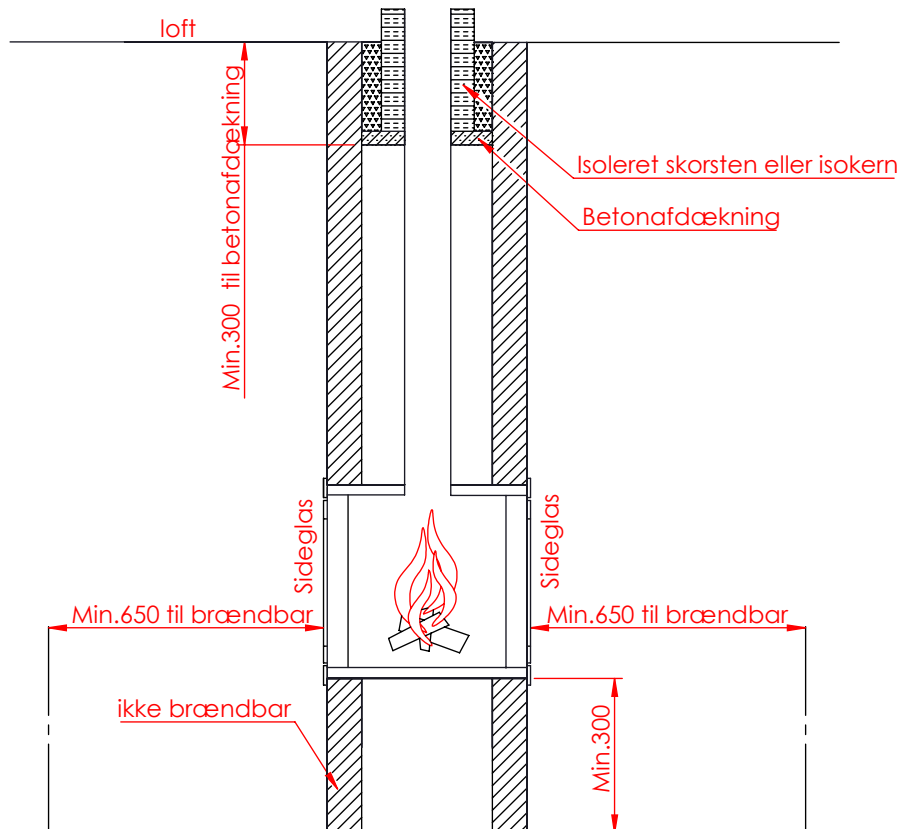

AFSTAND TIL BRÆNDBART