

TORINO WITH DENVER F6 BURNER™

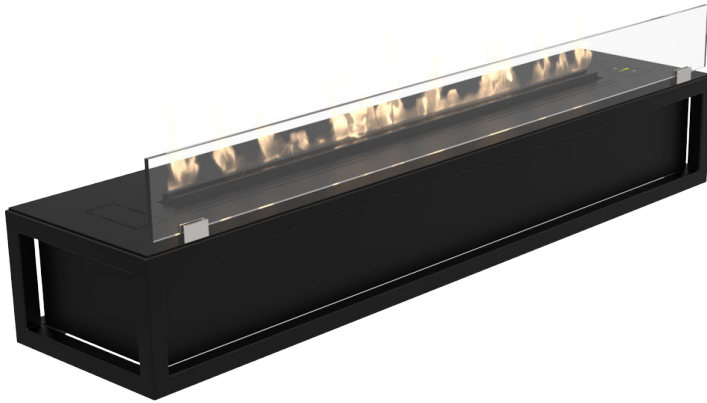

Torino bioethanol fireplace has been designed as a hang-on-the-wall piece of furniture with clean and minimalistic lines that incorporates the automatic Denver F6 burner.

The fireplace is easy to install as it can be simply hanged anywhere in the house sharpness and style to an interior.

Moreover, it has never been easier to operate a fireplace as the burner can be controlled automatically via Decoflame App or a remote control.

STANDARD FINISH



TECHNICAL INFORMATION

Capacity:	4L / 5.8L / 7.2L
Flame tray:	500mm / 700mm / 900mm
Burning time Hours:	Around 7-20 <i>Depending on flame intensity and air flow</i>
Heat output kWh:	1.2-3.2 / 1.6-4.3 / 2.1-5.7
Min. room size m ³ :	64 / 89 / 115
Power supply:	220V – 240V – 50 Hz
Burner:	Automatic Denver F6 Burner
Materials:	Frame: Steel pipes Topplate: Steel 80mm high hardened glass
Finish frame:	Powder coated black or white Optional finish (RAL) on request
Topplate finish:	Black or white
Fuel:	Bioethanol at 96.5 - 97.5%

FEATURES

- No chimney required
- No smoke, ash or soot
- Fuel and Flame level indicator
- Remot control included
- External Pump included
- Bluetooth / App
- Safety Sensors and Safety Chamber

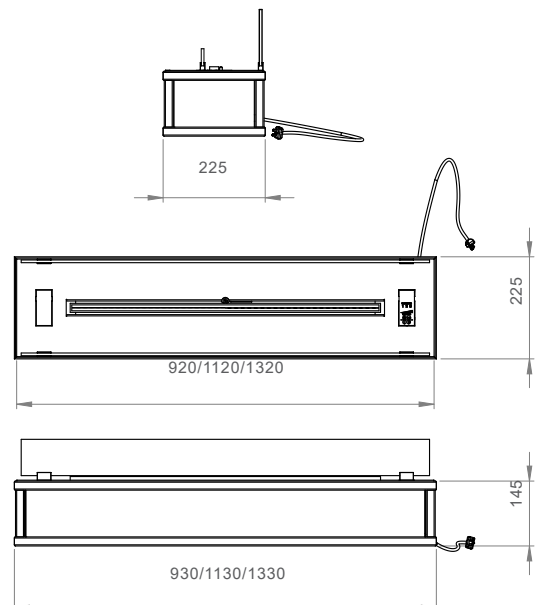

DENVER F6 BURNER

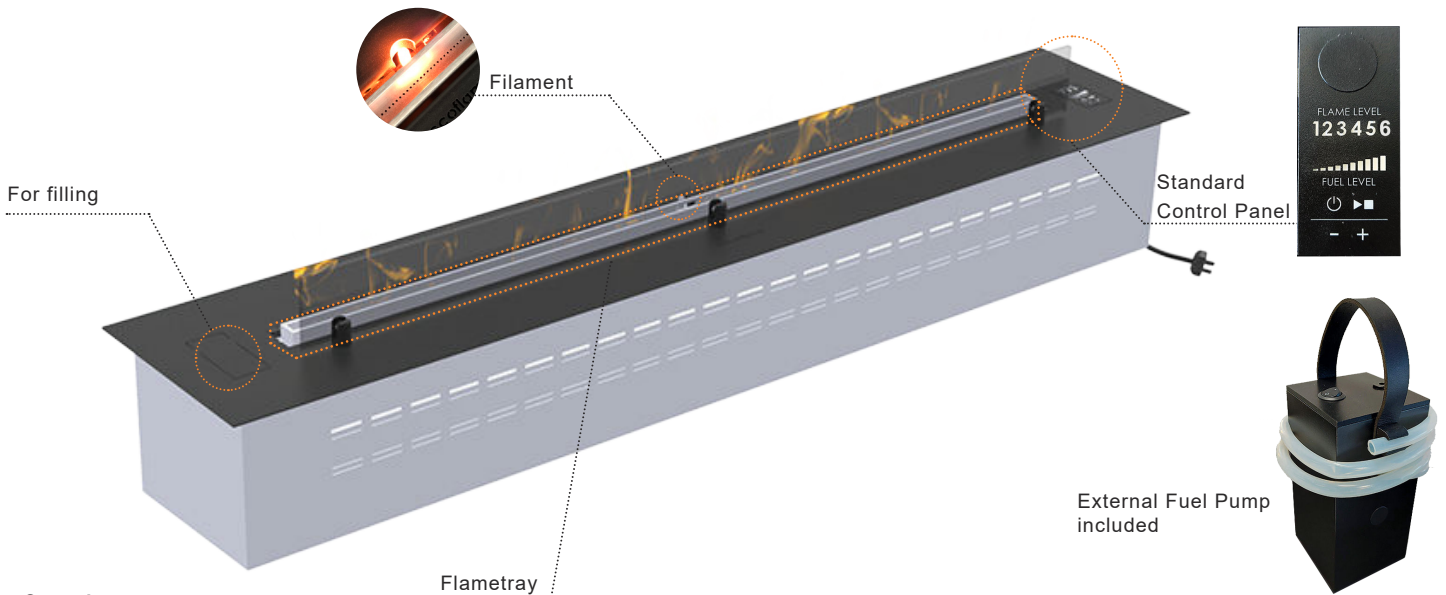

Operating:

Step 1	Turn on the electronics of your Denver F6™ by pressing the button.
Step 2	Fill in the right amount of bioethanol in the fuel tank by verifying the level on the fuel level indicator.
Step 3	To ignite the fireplace: Press the button on the control panel. After about 3 minutes, the first flames will appear around the centre of the flame tray.
Step 4	When the filament no longer is red/glow (approx. 10 min) it is possible to adjust the flames.
Step 5	To switch off the fire at any time – also during the warming-up phase – press the button on the control panel. The flames will disappear within few minutes.



Use the supplied remote control or download the Decoflame App to your mobile device for controlling the biofireplace.

Installation of Decoflame App to the Denver F6 burner



App Store



Google play

Model:	Denver Basic 720 - black	
Dimensions:	720x215x125mm - Flame Tray 500	
Power Supply:	220/240V - 50Hz must be earthed	
Serial Number:	72000.05.16.V1.001	
Thermal Output:	max 2.9 kW	
Fuel Type:	bioethanol 96%	
Room Volume:	min. 58 m ³	
Radio Frequency:	433.92 MHz	
Bluetooth Code:	0001	
Manufacturer:	Decoflame ApS - Made in Denmark	

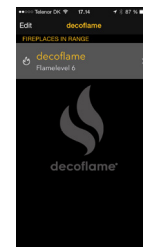

1. Download and install the Decoflame App corresponding to your smart device's operating system. For more information go to: decoflame.com.

2. In order to pair your fireplace with your smart device, start the fireplace by pressing the 'ON' button. Start the App and choose your fireplace. Insert the code from YOUR rating plate, like the one highlighted above.

3. Once your device is paired, the fireplace should be visible on the app. You are now able to change the name of the fireplace. **Note:** You are able to pair more than one fireplace like described in the step nr. 2 and give them different names.

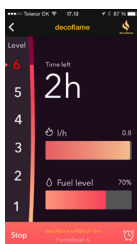

4. Once you have selected your fireplace, you can turn it on by pressing 'START'. If the fireplace has already been turned on using the control panel, you can now monitor the fuel level and the consumption.

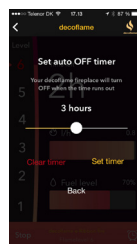

5. For the 'Turn Off Timer' press the clock icon in the lower right corner. To adjust the remaining time, slide the dot to the left and right and select 'SET TIMER'. The remaining burning time can be changed by repeating the above mentioned steps. To cancel the timer select 'CLEAR TIMER'.

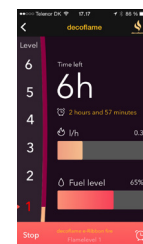

6. For adjusting the flame intensity, select the desired level on the left side of the screen. (1-lowest, 5+ECO Wave or 6-highest depending on the model chosen). Should there not be enough fuel for the selected burning time - the fireplace will shut down automatically. Select 'STOP' to turn off the fireplace.